



ARTOME



Disrupting the AV-industry

Redesigning audiovisual

Professional AV-integrator got tired of continuous travelling, poorly scheduled projects and pending workhours. Toni Parikka was just a guy, who wanted to settle down and start a family. Instead of one, he now has two -one at home and one called Artome, which brings installation free and easiness of use to the whole AV-industry.

All-in-one

All-in-one solution

Built-in laser projector, embedded sound system and videoconferencing capabilities.

Installation free

Eliminates the need for electrical planning and cabling. Saves both time and money in construction.

Movable

Transforms any space for presentation, learning and hybrid working.



Adaptable

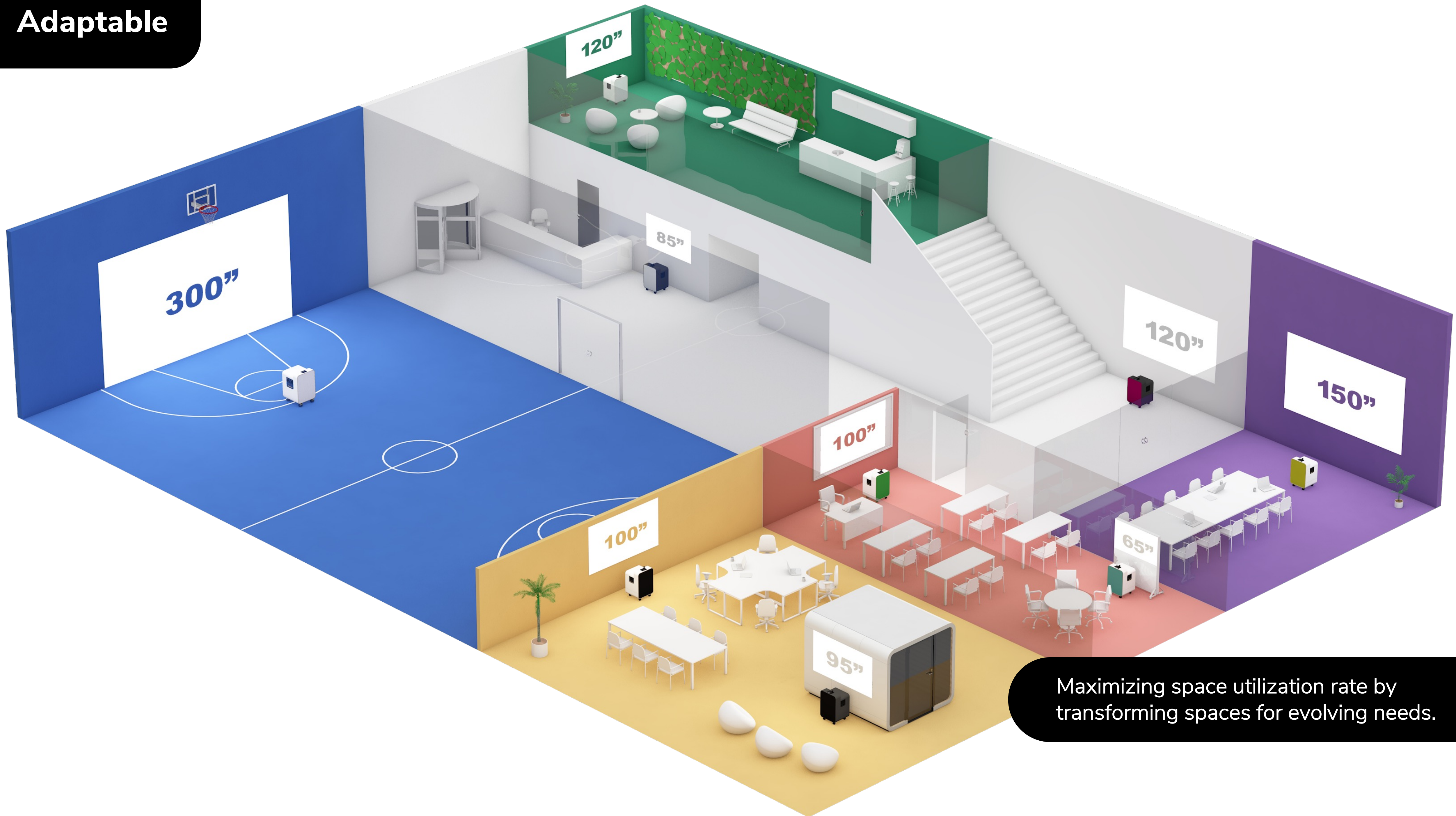

Maximizing space utilization rate by transforming spaces for evolving needs.

Easy

Easy to adopt

No electrical planning or expertise on audiovisual technology is needed.

Easy to use

In a factory-made solution all the functions work seamlessly together.

Easy to trust

The whole smart furniture set up is being supported by a single point of contact.





- Scandinavian design furniture
- Scalable image size
- Sound system for bigger audiences
- Plug-and-play videoconferencing

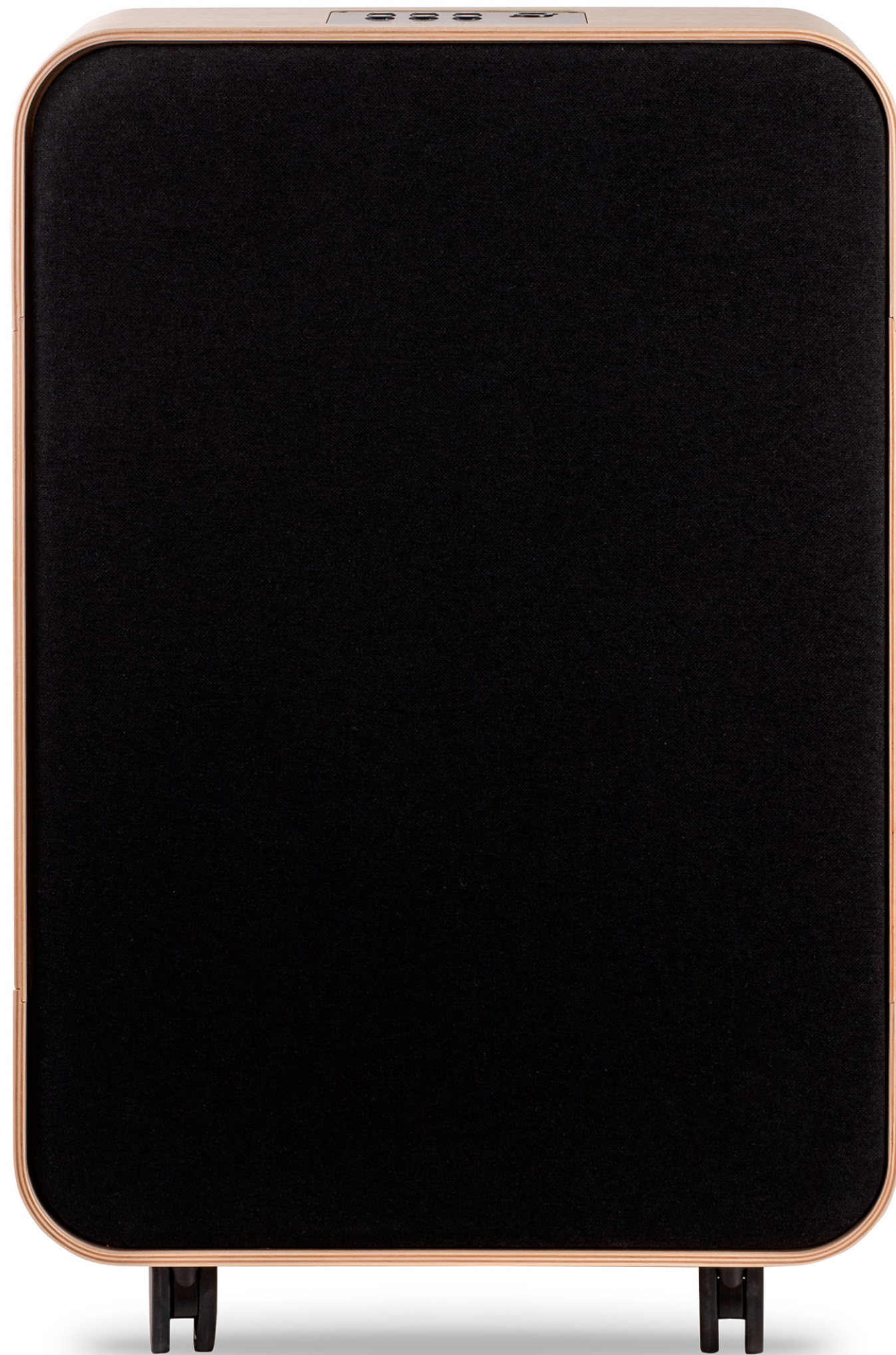

Artome M10 - All-in-one audiovisual solution

Flexibility and ease of use without forgetting the aesthetic side

Artome M10 enables plug&play video conferencing set-up with casting from a laptop or other device. It is installation free and compatible with any device or software. Thanks to our own technology innovation HybriDock™, that enables the use of (integrated) camera and microphones.

Functions

Artome M10

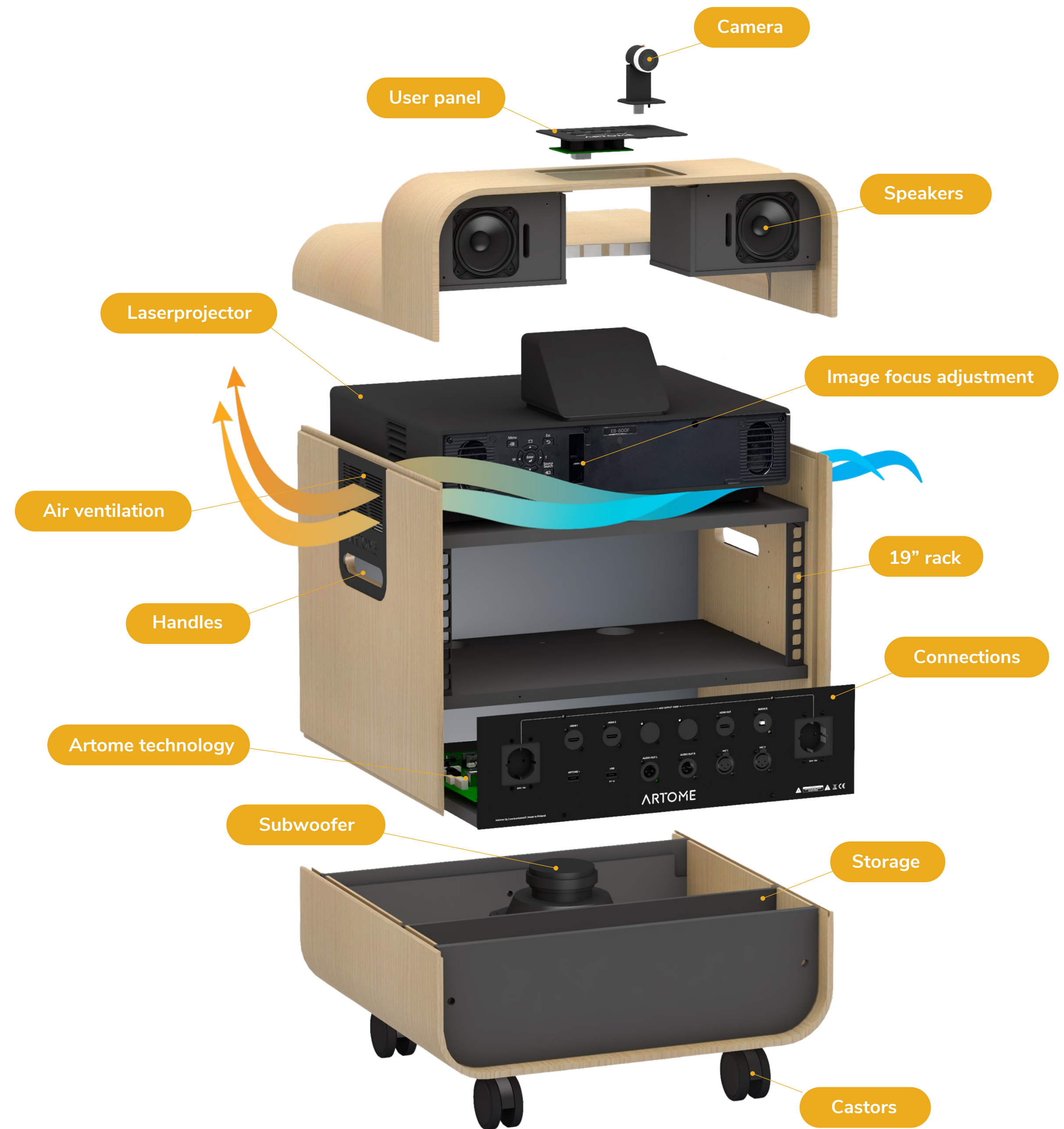

Connection panel

Artome M10



User Panel

Artome M10





White laminate



Black Stained ash



Laquered ash

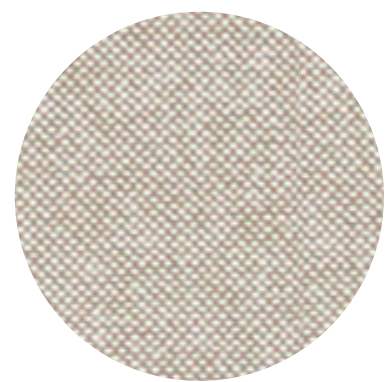

Sand



Black

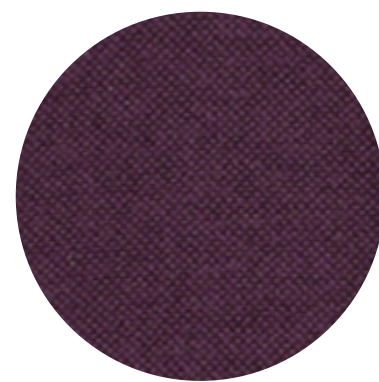

Dark grape

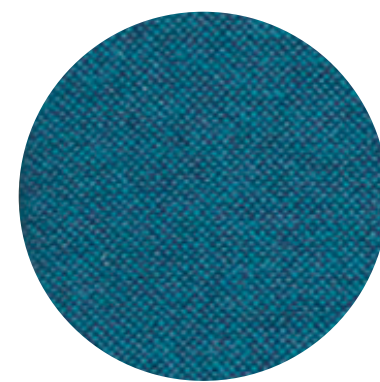

Lagoon

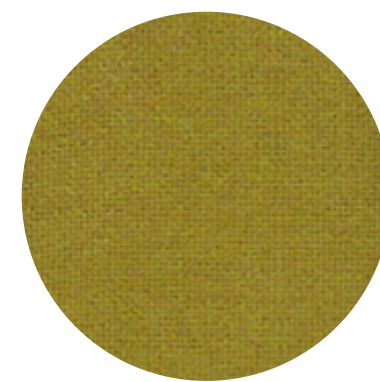

Saffron

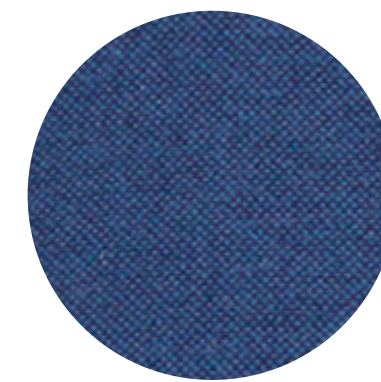

Sea

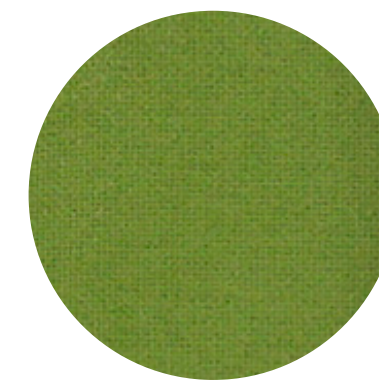

Grass

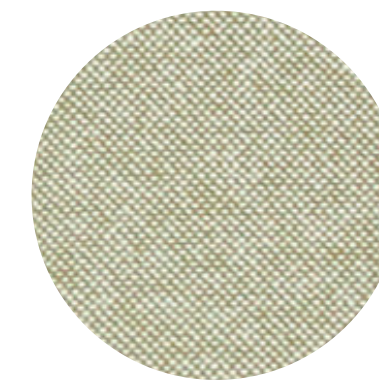

Taupe

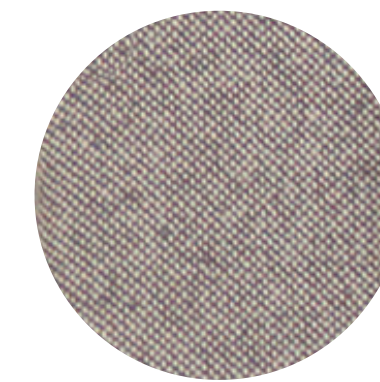

Melange



Artome X20 – Double the experience

Scalable audiovisual solution for large spaces

Artome X20 transforms a gymnasium into an event venue or a lobby into a stage instantly, as it brings an extensive experience to any space. The light output of 7000-10000 lumens produced by the Epson laser projector meets the needs of the most challenging and bright spaces. The embedded soundsystem offers powerful sound to meet the needs of a larger audience for example in an auditorium or gymnasium.

Functions

Artome X20



Connection panel

Artome X20



User Panel

Artome X20









Menu

Home

Enter

T
Source
Search

Esc

Focus

EB-805F
S/N: X062130004L



HOMEWORK
△ p. 30-32
○ CHAPTER 7
□



ARTOME X20









ARTOME







USB

AUDIO OUT L

AUDIO OUT R

ARTOME







ARTOME

PAUSE

VOLUME+

SOURCE

FREEZE

VOLUME-

POWER





POWER

USE ONLY 250V FUSE

HDBT

CAT5

ARTOME

ARTOME



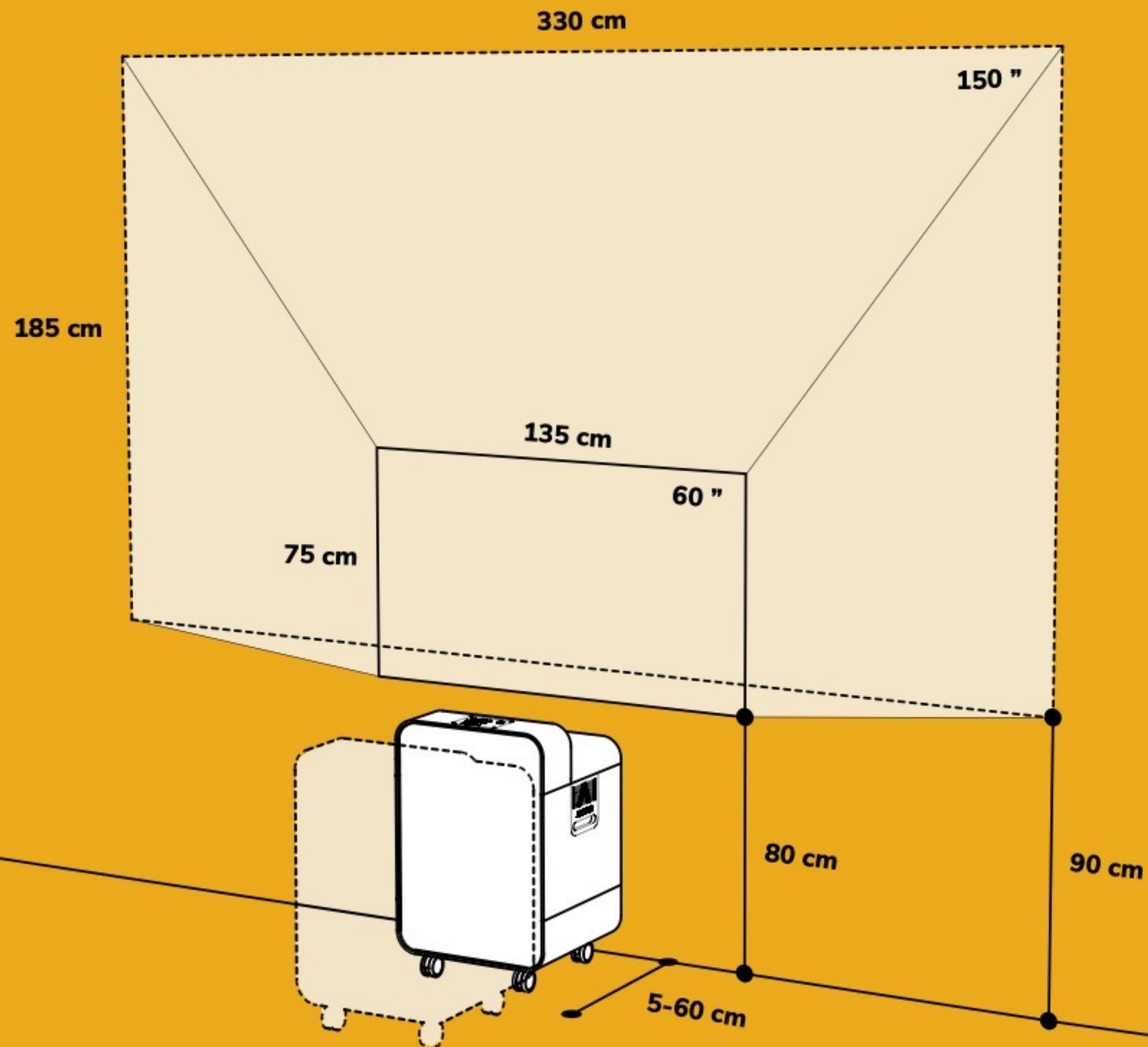

General specs

Name	Artome M10
Materials	Birch plywood, MDF, steel, aluminum, plastic (PA)
Dimensions	(W x H x D) 52 x 80 x 47,5 cm / 20.4" x 31.4" x 18.7"
Weight (excl. projector)	40 kg / 88 lb
Warranty (excl. projector)	24 months

Technical specs

Supply Voltage	100-240V~ 50/60Hz
Power consumption (excl. projector)	100 W
Sound	2.1 -speaker system
Operating temperature	0-30 °C / 32-86 °F
Artome HybriDock™	USB 3.0 hub, USB audio interface
19" rack	3U x 257 mm (depth)
Controls	Power, Source, Vol +/-, Pause, Freeze
Connections	HDMI in, Mic in x2, Stereo audio out (balanced), HDBaseT Power outlet x2 (100-240V~ 50/60Hz 1.5A)

Projector specs

Compatible projectors	Epson: EB-800F / EB-805F
Brightness	5000 lm
Image size	60-150"
Resolution	1080p
Aspect ratio	16:9
Power consumption	366 W
Weight	9,4 kg / 20.7 lb
Warranty	60 months or 12.000 h

ARTOME X20



General specs

Name	Artome X20
Materials	Birch plywood, MDF, steel, aluminum, plastic (PA)
Dimensions	(W x H x D) 62 x 95 x 63 cm / 24,40" x 37,40" x 24,80"
Weight (excl. projector)	60 kg / 132 lb
Warranty (excl. projector)	24 months

Technical specs

Supply Voltage	100-240V~ 50/60Hz
Power consumption (excl. projector)	150 W
Sound	2.1 -speaker system
Operating tempature	0-30 °C / 32-86 °F
Artome HybriDock™	USB 3.0 hub, USB audio interface
19" rack	2U x 345 mm (depth)
Controls	Power, Source, Vol +/-, Pause, Freeze
Connections	HDMI in, Mic in x2, Stereo audio out (balanced), HDBaseT Power outlet x2 (100-240V~ 50/60Hz 3A)

Projector specs

Compatible projectors	Epson: EB-PU1007 / EB-PU1008 / EB-PU2010
Compatible lenses	ELPLU04, ELPLW06, ELPLM15, ELPLL08
Brightness	7000 / 8000 / 10000 lm
Image size	150-300"
Resolution	WUXGA
Aspect ratio	16:10
Power consumption	431 / 535 / 535 W
Weight (incl. lens)	20 kg / 44 lb
Warranty	36 months